



sistema video 4+n
video system 4+n

SYNTHESI
2000

 **AMPLYVOX**

**INDICE:**

Descrizione	Schema	Pag.
Sezione conduttori		2/IT
Suggerimenti per la corretta installazione		3/IT
Funzione morsetti monitor Synthesi cod. 8435/5		4/IT
Funzione morsetti alimentatore cod. 8605		5/IT
Funzione morsetti posto esterno cod. 2055		5/IT
Funzione morsetti gruppo di ripresa cod. 8055/29 – 8055/80		6/IT
Funzione morsetti modulo telecamera esterna cod. 8055/TX		6/IT
Funzione morsetti commutatore cod. 8845		7/IT
Esempio di collegamento del circuito diodi cod. 2610/4		8/IT
IMPIANTI VIDEOCITOFONICI SYNTHESI (4+n)		
Kit unifamiliare	5801#	1
Kit unifamiliare con telecamera esterna	5811#	2
Kit bifamiliare	5802#	3
Kit bifamiliare con telecamera esterna	5812#	4
Impianto plurifamiliare	5820#	5
Impianto plurifamiliare commutato : una pulsantiera video e una audio	5840#	6
Impianto plurifamiliare commutato : due pulsantiere videocitofoniche	5841#	7
Impianto plurifamiliare commutato : tre o piu' pulsantiere videocitofoniche principali	5851#	8
Collegamento derivatore video		9
Collegamento di un monitor in parallelo		10
Collegamento di un citofono in parallelo		10
Collegamento di tre monitori in parallelo senza derivatore		11
Collegamento con richiamo video dal monitor		12
Collegamento con chiamata di piano		12
Collegamento del ripetitore di chiamata cod. 853/1		13
Collegamento in caso di lunghe distanze		13

AVVERTENZE

- a) Si raccomanda di utilizzare componenti originali AMPLYVOX.
 b) La AMPLYVOX S.p.A. si riserva la facolta' di variare le caratteristiche tecniche, estetiche e dimensionali delle apparecchiature descritte in questo schemario senza alcun preavviso.

NOTE

PER FACILITARE LA LETTURA DELLO SCHEMA DI COLLEGAMENTO LA DISPOSIZIONE DEI MORSETTI PUO' NON CORRISPONDERE ALLA REALE DISPOSIZIONE DEI MEDESIMI SUGLI APPARECCHI.

SI RACCOMANDA DI NON SERRARE OLTRE MISURA LE VITI DEI MORSETTI DELLE APPARECCHIATURE PERCHE' OLTRE CHE INUTILE, L'ECESSIVA PRESSIONE ASSIALE SUL MORSETTO POTREBBE DANNEGGIARE IL CIRCUITO STAMPATO SOTTOSTANTE.

LEGENDA :

- Y PULSANTE APRIPORTA
 J CHIAMATA DI PIANO
 S.E. SERRATURA ELETTRICA 12Vca – 18VA
 R RESISTENZA DI CARICO 75 ohm ½ W
 ... LAMPADA PORTACARTELLINI 24V – 3W

Tabella sezione conduttori

Distanza	Conduttori Monitore			Conduttori Alimentatore
	+ O	R X CP	1 2	
50 mt.	1 mm ²	0.5 mm ²	0.3 mm ²	1.5 mm ²
100 mt.	1.5 mm ²	1 mm ²	0.3 mm ²	2 mm ²
200 mt.	2.5 mm ²	1.5 mm ²	0.3 mm ² twistato	2.5 mm ²

Suggerimenti per posa in opera :

Pulsantiera video
 (cod. 806.../n)
 (Mosaico)

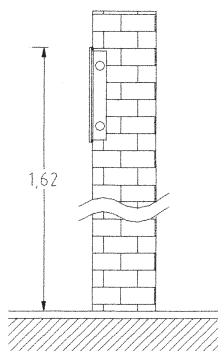

Monitore
 (cod. 8435/5)

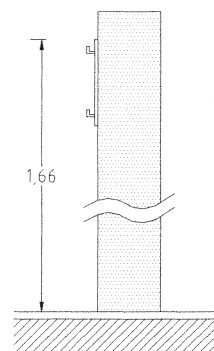



Suggerimenti per la corretta installazione

- 1) Non effettuare collegamenti, sostituzioni ed altre operazioni ad impianto alimentato.
- 2) Installare il modulo unità da ripresa all'altezza indicata sulla scatola da incasso evitando di posizionare la telecamera controluce.
- 3) Non canalizzare i conduttori videocitofonici con i conduttori di rete.
- 4) In presenza di più morsetti "H" sulle apparecchiature, il collegamento dei conduttori interessati a tali terminali risulta indifferente.
- 5) Le telecamere CCD sono corredate di illuminatori all'infrarosso che permettono una adeguata visione notturna del primo piano del visitatore.
- 6) Per l'accensione delle lampadine nella pulsantiera, prevedere un trasformatore dedicato (di potenza adeguata al numero delle lampade) ed i relativi due conduttori di alimentazione.

Controlli preliminari

Prima di collegare l'impianto è opportuno effettuare i seguenti controlli:

- 1) Accertare la corrispondenza dei collegamenti secondo gli schemi forniti con l'apparecchiatura.
- 2) Accertare che tra i morsetti "H" e "+F" non sia presente un corto circuito.
- 3) Accertare che tra i morsetti "0" e "+" non sia presente un corto circuito.
- 4) I conduttori "1" e "2" in partenza dal gruppo di ripresa devono presentare ciascuno una resistenza prossima ai 75 ohm .
N.B. Tale misurazione non e' valida per impianti unifamiliari (senza derivatore).

Prove di funzionamento

- 1) Alimentare il sistema.
- 2) Premere un pulsante del modulo unità da ripresa, verificare la ricezione della chiamata e la conseguente accensione del monitor con immagine stabile e definita. E' possibile regolare luminosità e contrasto dell'immagine agendo sugli appositi comandi.
- 3) Attendere lo spegnimento ed eventualmente ripetere la chiamata su altri monitori (nel caso di impianto plurifamiliare). Un particolare circuito nel gruppo di ripresa evita l'accensione contemporanea di più monitori.
- 4) La prova fonica deve essere effettuata parlando alla distanza di 30 cm. dal posto esterno audio.
Il posto esterno è normalmente tarato all'atto del collaudo. Nel caso si rendesse necessaria una regolazione differente, si dovrà agire sui potenziometri posti sul lato posteriore:

"A" = volume interno - esterno

"B" = volume esterno - interno

Il controllo della regolazione dovrà essere effettuato con la pulsantiera in opera per tenere conto delle effettive condizioni acustiche, dando comunque la precedenza al volume A.

Si consiglia di evitare in ogni caso di alzare i volumi ad un livello tale da provocare il fischio per effetto Larsen.

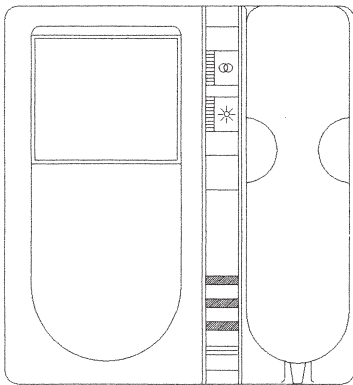

MONITORE SYNTHESI Cod. 8435/5

- Schermo piatto 4" a visione diretta
- Chiamata elettronica in altoparlante proveniente dalla pulsantiera esterna.
- Chiamata elettronica di piano in altoparlante con frequenza diversa da quella proveniente dall'esterno.
- Pulsante apertura serratura.
- Pulsante richiamo video.
- Pulsante comando ausiliario.
- Regolazioni contrasto e luminosita'.
- Segreto di conversazione (escludibile).
- Cablaggio video bilanciato tramite distributore o collegamento "entra - esci".

Dimensioni : 204 x 220 x 50 mm

Mobile : tecnopolimero

Jumpers

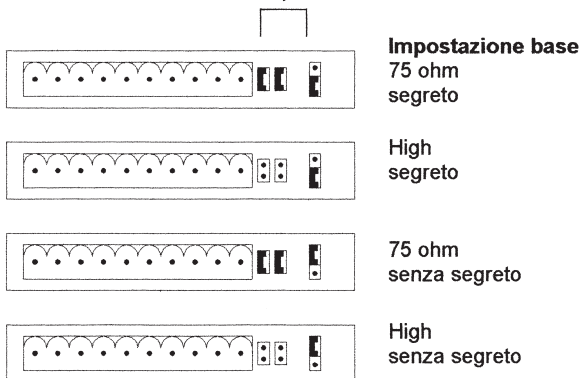

IMPORTANTE !

Utilizzare i jumpers nel seguente modo :

Negli impianti con distributore video, lasciare inseriti entrambi i jumpers (rif. 75 ohm).

Negli impianti con collegamento video "entra - esci" estrarre entrambi i jumpers (rif. High).

IMPORTANTE !

Tutti i monitori devono avere il jumper "SEGRETO" nella medesima posizione.

FUNZIONE MORSETTI

m.	Valore	Funzione	Note
1		Segnale video positivo	Segnale video composito 1 Vpp
2		Segnale video negativo	Segnale video composito 1 Vpp
O	0 V	Massa	Permanente
+	+18 V =	Tensione temporizzata	Presente durante la temporizzazione
R	+10 V = chiuso + 5 V = aperto - 5 V = 0 V	Ingresso fonica Chiamata elettronica Comando serratura	
X	+18 V =	Chiamata elettronica di piano	
CP		Richiamo video	
CL	Contatto NA	Contatto ausiliario	Funzione speciale
CC	Contatto Comune	Contatto ausiliario	Funzione speciale
CR	Contatto NC	Contatto ausiliario	Funzione speciale

Cod. 8435/5



ALIMENTATORE Cod. 8605

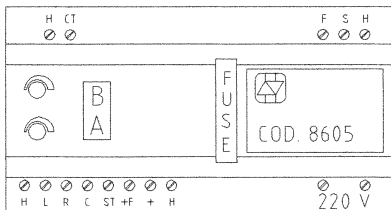

Dimensioni : 185 x 100 x 77 mm
 Mobile : ABS (fissaggio barra DIN)

Protezioni : Fusibile T 200 mA (primario trasformatore)
 Fusibile F 3.15 A (secondario trasformatore)

FUNZIONE MORSETTI

Cod. 8605

m.	Valore	Funzione	Note
H	0 V	Massa	Riferimento per tutte le tensioni
F	16 V ~	Alimentazione gruppo di ripresa	Permanente
+F	+18 V =	Alimentazione gruppo di ripresa	Permanente
CT		Comando tensione temporizzata	Funzione alimentazione supplementare
+	+18 V =	Tensione temporizzata	Funzione alimentazione supplementare
ST	+18 V =	Tensione presente solo in assenza del comando	Funzione speciale
L	Contatto NA	Contatto ausiliario	Funzione speciale
R	Contatto NC	Contatto ausiliario	Funzione speciale
C	Contatto Comune	Contatto ausiliario	Funzione speciale
S	22 V ~	Alimentazione servizi	Permanente
220	230 Vca	Ingresso alimentazione	Rete

ITALIANO

POSTO ESTERNO Cod. 2055

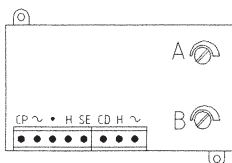

Dimensioni : 94 x 57 x 35 mm
 Mobile : ABS

Regolazioni : Potenziometro A (volume interno – esterno)
 Potenziometro B (volume esterno – interno)

FUNZIONE MORSETTI

Cod. 2055

m.	Valore	Funzione	Note
CP		Comune pulsanti	Giallo
~	16 V ~	Alimentazione	Rosso
•		Comando commutazione	Verde
H	0 V	Massa	Nero
SE		Comando serratura elettrica	Blu
CD		Comune anodo circuito diodi	Marrone
H	0 V	Massa	Nero
~	16 V ~	Alimentazione	Rosso

GRUPPO DI RIPRESA

Cod. 8055/80

Cod. 8055/29

Cod. 8055/TX

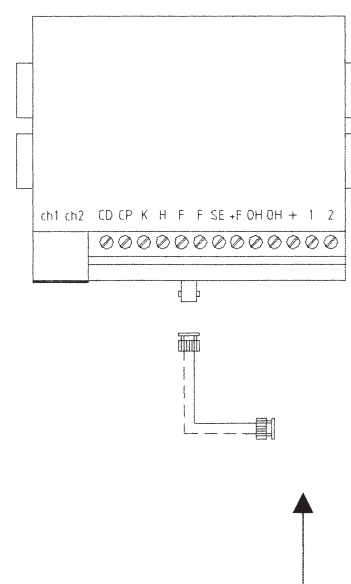
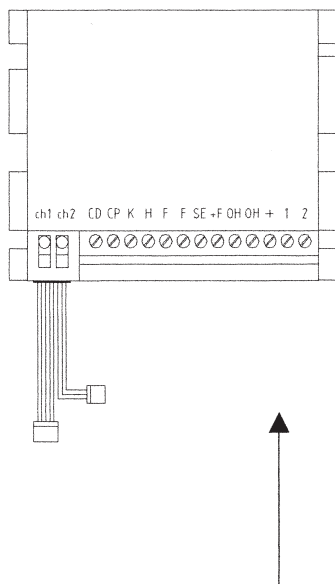
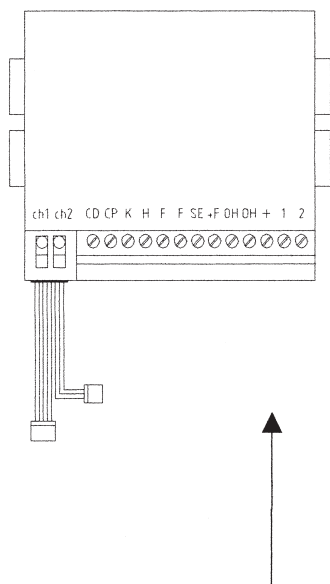

Utilizzata con la pulsantiera
"COMPONIBILE"

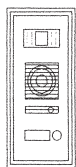

Utilizzata con la pulsantiera
"MOSAICO"

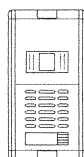

Utilizzata con la
TELECAMERA ESTERNA

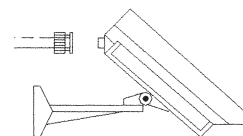

FUNZIONE MORSETTI

m.	Valore	Funzione	Note
CD		Comune anodo circuito diodi	
CP		Comune pulsanti	
K	+12 V = riposo 0 V chiamata	Comando commutazione	
H	0 V	Massa	Riferimento per tutte le tensioni
F	16 V ~	Alimentazione gruppo di ripresa	Permanente
SE	16 V ~ aperto 0 V chiuso	Comando serratura elettrica	
OH	0 V	Massa	Riferimento per tutte le tensioni
+F	+18 V =	Alimentazione gruppo di ripresa	Permanente
+	+18 V =	Tensione temporizzata	Temporizzazione 60 sec. circa
1		Segnale video positivo	Segnale video composito 1 Vpp
2		Segnale video negativo	Segnale video composito 1 Vpp
Ch1		Catodo diodo	Utilizzato esclusivamente nei kit
Ch2		Catodo diodo	Utilizzato esclusivamente nei kit

Cod. 8055 / TX

K	+12 V = riposo 0 V chiamata	Comando commutazione	
OH	0 V	Massa	Riferimento per tutte le tensioni
+F	+18 V =	Alimentazione gruppo di ripresa	Permanente
+	+18 V =	Tensione temporizzata	Temporizzazione 60 sec. circa
1		Segnale video positivo	Segnale video composito 1 Vpp
2		Segnale video negativo	Segnale video composito 1 Vpp
	75 Ω	BNC Cavo coassiale	Segnale video composito 1 Vpp

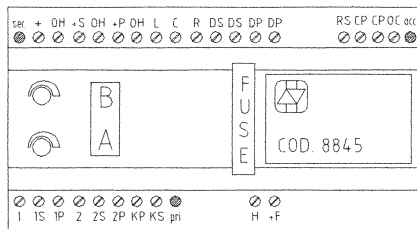
**COMMUTATORE Cod. 8845**

Dimensioni : 185 x 100 x 77 mm

Mobile : ABS (fissaggio barra DIN)

Protezioni : fusibile 1 A

LED di SEGNALAZIONE:**PRI** I contatti Comune sono chiusi ohmicamente con i contatti NC**SEC** I contatti Comune sono chiusi ohmicamente con i contatti NA**OCC** la gestione della segnalazione OCCUPATO è attiva**FUNZIONE
MORSETTI****Cod. 8845**

m.	Valore	Funzione	Note
+F	+18 V=	Alimentazione	Permanente
OH	0 V	Massa	Riferimento per tutte le tensioni
KP	+12 V= riposo 0 V chiamata	Comando di reset	
KS	+12 V= riposo 0 V chiamata	Comando di set	
RS		Gestione occupato	Funzione speciale
OC		Comando segnalazione di occupato	Funzione speciale
1		Segnale video positivo	Contatto Comune
1P		Segnale video positivo	Contatto NC
1S		Segnale video positivo	Contatto NA
2		Segnale video negativo	Contatto Comune
2P		Segnale video negativo	Contatto NC
2S		Segnale video negativo	Contatto NA
+	+18 V=	Alimentazione monitori	Contatto Comune
+P	+18 V=	Alimentazione monitori	Contatto NC
+S	+18 V=	Alimentazione monitori	Contatto NA
DS		Comune anodo circuito diodi	Contatto Comune
DS		Comune anodo circuito diodi	Contatto NA
DP		Comune anodo circuito diodi	Contatto Comune
DP		Comune anodo circuito diodi	Contatto NC
CP		Comune pulsanti	Contatto Comune
CP		Comune pulsanti	Contatto NC
C		Contatto ausiliario	Contatto Comune
R		Contatto ausiliario	Contatto NC
L		Contatto ausiliario	Contatto NA

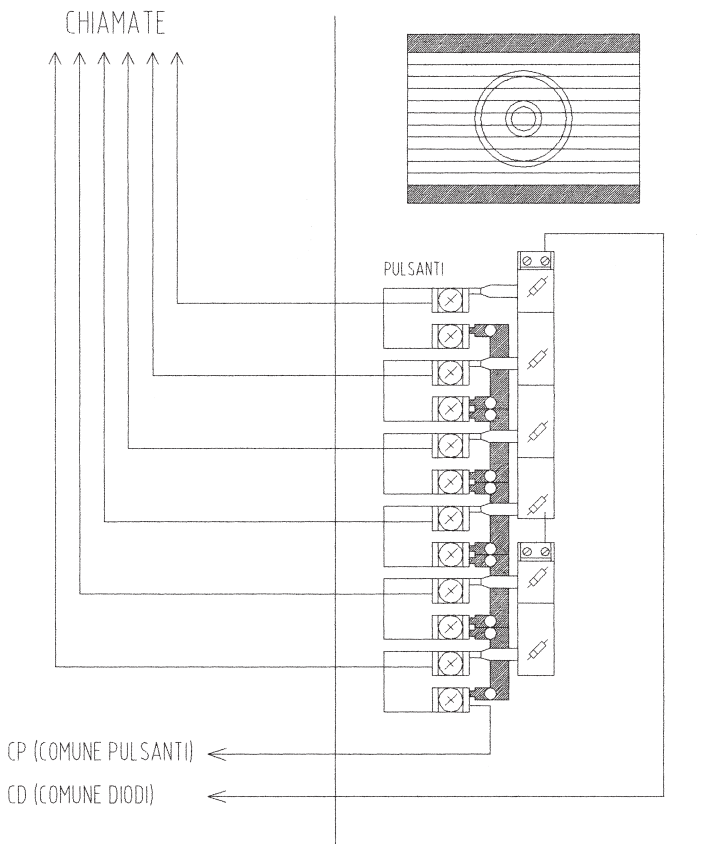

**ESEMPIO DI COLLEGAMENTO
NELLA PULSANTIERA**

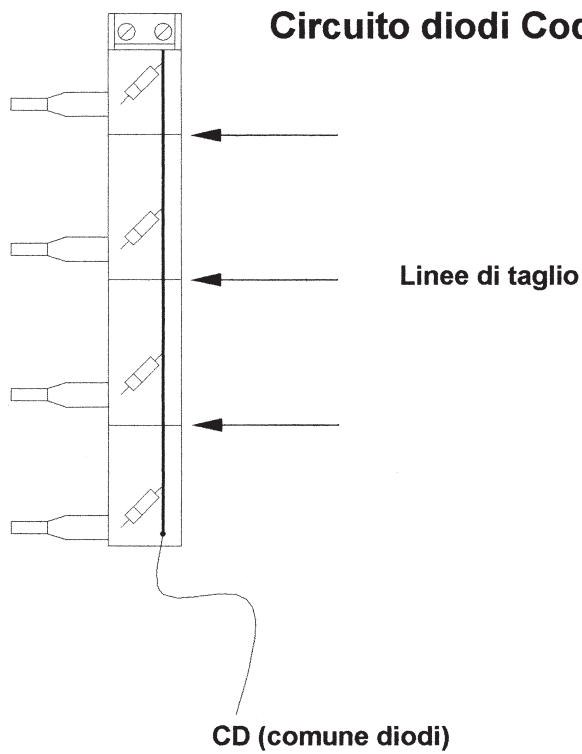



INDEX:

Description	Diagram	Page
Section of wires		2/UK
Suggestions for the correct installation		3/UK
Terminal functions monitor Synthesi code 8435/5		4/UK
Power supply terminal functions code 8605		5/UK
Audio speaker unit terminal functions code 2055		5/UK
Camera group terminal functions code 8055/29 – 8055/80		6/UK
Interface module for external camera code 8055/TX		6/UK
Automatic switch terminal functions code 8845		7/UK
Connection diodes circuit code 2610/4		8/UK
VIDEO DOOR ENTRY SYSTEM SYNTHESI (4+n)		
Single residence kit	5801#	1
Single residence kit with external camera	5811#	2
Dual residence kit	5802#	3
Dual residence kit with external camera	5812#	4
Multi users video door entry system	5820#	5
Automatic switching for two entrance panels : one video and one only audio	5840#	6
Automatic switching for two video entrance panels	5841#	7
Automatic switching for three or more main video entrance panels	5851#	8
Video distributor		9
Monitor in parallel		10
Telephone in parallel		10
Three monitors in parallel without video distributor		11
Monitor with video recall		12
Apartment entrance door call		12
Passive repeater for additional call		13
Long distance connection		13

NOTE

- a) AMPLYVOX S.p.A suggests to use original components only.
- b) AMPLYVOX S.p.A. reserves the right to modify the design, construction, composition and equipment as it shall think fit without notifying the buyer and to supply products which may not be in strict accordance with agreed specifications.

TO FACILITATE THE READING OF THE DIAGRAM, TERMINAL DATA MAY NOT CORRESPOND TO THE POSITION INDICATED ON THE EQUIPMENT.

TO AVOID DAMAGE TO THE PRINTED CIRCUIT, WE SUGGEST THAT TERMINALS ARE NOT OVER TIGHTENED.

LEGEND :

- Y DOOR OPENER BUTTON
 J APARTMENT CALL
 S.E. ELECTRIC LOCK 12Vac – 18VA
 R CHARGE RESISTOR 75 ohm ½ W
 ... NAME LABEL FESTOON BULB 24V – 3W

Section of wires

Distance	Monitor			Power supply
	+ O	R X CP	1 2	F H +F OH
50 mt.	1 mm ²	0.5 mm ²	0.3 mm ²	1.5 mm ²
100 mt.	1.5 mm ²	1 mm ²	0.3 mm ²	2 mm ²
200 mt.	2.5 mm ²	1.5 mm ²	0.3 mm ² twisted	2.5 mm ²

Suggested installation heights :

Video entrance panel
 (code 806.../n)
 (Mosaico)

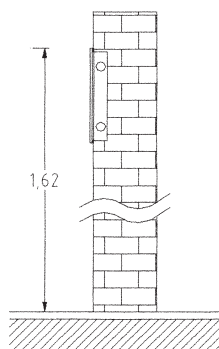

Monitor wall mount bracket
 (code 8435/5)

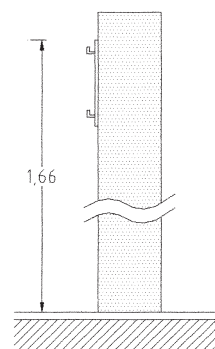



Suggestions for the Correct installation

- 1) Do not execute any connection, replacement or operation with the system powered.
- 2) Be carefull installing the external video entrance panel to the right indicated height and avoid installing the camera group in direct view of sunlight.
- 3) Do not run the cables of the video door system in the same duct of the mains network.
- 4) There are more than one "H" terminals on the equipments, it makes no difference which "H" terminal is used.
- 5) The CCD video camera is normally supplied with infrared leds built in, to allows a correct vision of the visitor.
- 6) To supply the name label festoon bulbs in the entrance panel a dedicated trasformer and its wires connection are suggested.

Preliminary checks

Before main connections:

- 1) Check that the connections are made following the drawing supplied with the equipment.
- 2) Check that no short circuit exists between terminals "H" and "+F".
- 3) Check that no short circuit exists between terminals "O" and "+".
- 4) The wires "1" and "2" starting from the camera group must present a resistance of about 75 ohms.
Note: this measurement is not valid for the single residence video kit.

Test of operations

- 1) Power the system.
- 2) Push the call button of the external video entrance panel and check if :
 - the electronic call sounds at the monitor.
 - the monitors image is clear, stable and defined.
 - the image needs regulating (operate on brightness and contrast controls).
- 3) Wait for the automatic turn off of the monitor, then repeat the call to the other apartments.
A special circuit in the camera group avoids the simultaneous turn on of more than one monitor.
- 5) The phonic test must be effected talking at a distance of 30 cms. from the external video entrance panel.
The volume of the amplifiers in the external audio unit is normally factory set, however if the amplification proves to be too high or too low, this can be adjusted accordingly via the two potentiometers "A" and "B" which can be found at the back of the external audio unit.

"A" = regulates the volume from the inside to the outside

"B" = regulates the volume from the outside to the inside

The amplification settings must be carried out with the unit in operation, so as to hear the effects of the settings.

It is important to start the adjustments with potentiometer "A".

However it is important to avoid increasing the volume to a very high level that will produce the feedback whistle due to the larsen effect.

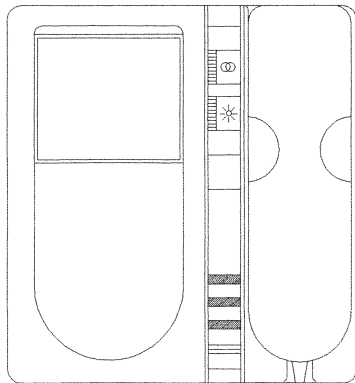

MONITOR SYNTHESI Code 8435/5

- . Picture tube: flat 4" screen.
- . Electronic call: loudspeaker.
- . Electronic front door apartment call: loudspeaker (different frequency).
- . 1 push-button: electric lock door release.
- . 1 push-button: video recall.
- . 1 push-button: auxiliary services.
- . Controls: brightness – contrast.
- . Privacy: built-in (can be excluded).
- . Video connection: with video distributor or “ in – out ” system.

Dimensions : 204 x 220 x 50 mm
 Housing : technopolymers

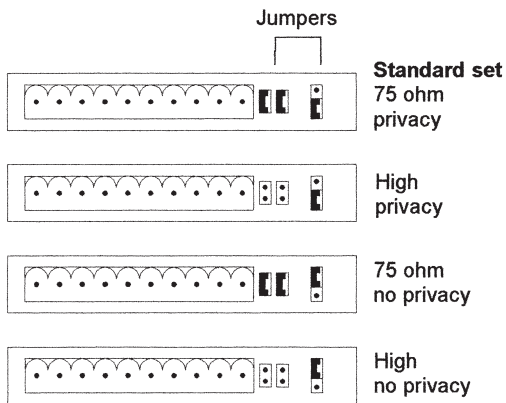

IMPORTANT !
Use jumpers in the following mode :
 Use both jumpers (ref. 75 ohm) in systems with video distributors.
 Remove both jumpers (ref. High) in systems without video distributors (in – out).

IMPORTANT !
 All monitors must have the “Privacy” jumper in the same position.

TERMINAL FUNCTIONS

Code 8435/5

T.	Value	Function	Note
1		Positive video signal	Composite video signal 1 Vpp
2		Negative video signal	Composite video signal 1 Vpp
O	0 V	General earth	All voltage reference level
+	+18 V =	Timed voltage	Stand on when timer is working
R	+10 V = closed + 5 V = opened - 5 V = 0 V	Phonic input Electronic call Electric lock release control	
X	+18 V =	Electronic front door call	
CP		Video recall	
CL	NO contact	Auxiliary contact at rest	Special function
CC	Common contact	Auxiliary contact common	Special function
CR	NC contact	Auxiliary contact at rest	Special function



POWER SUPPLY Code 8605

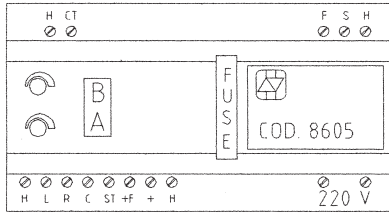

Dimension : 185 x 100 x 77 mm
 Housing : ABS (DIN module)

Protections : Fuse T 200 mA (primary trasformer)
 Fuse F 3.15 A (secondary trasformer)

TERMINAL FUNCTIONS

Code 8605

T.	Value	Function	Note
H	0 V	General earth	All voltage reference level
F	16 V ~	Camera group supply	Stand on terminal
+F	+18 V =	Camera group supply	Stand on terminal
CT		External timer set	Additional supply function
+	+18 V =	Timed voltage	Additional supply function
ST	+18 V =	Voltage present at rest	Special function
L	NO contact	Auxiliary contact at rest	Special function
R	NC contact	Auxiliary contact at rest	Special function
C	Common contact	Auxiliary common contact	Special function
S	22 V ~	A.C. voltage-services supply	Stand on terminal
220	230 Vac	Input voltage	Main

ENGLISH

AUDIO SPEAKER UNIT Code 2055

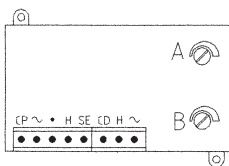

Dimensions : 94 x 57 x 35 mm
 Hosing : ABS

Regulations : Potentiometer A (volume from the inside to the outside)
 Potentiometer B (volume from the outside to the inside)

TERMINAL FUNCTIONS

Code 2055

T.	Value	Function	Note
CP		Common push button	Yellow
~	16 V ~	Supply	Red
•		Switch set	Green
H	0 V	General earth	Black
SE		Electric lock door release	Blue
CD		Common anode diodes circuits	Brown
H	0 V	General earth	Black
~	16 V ~	Supply	Red

CAMERA GROUP

Cod. 8055/80

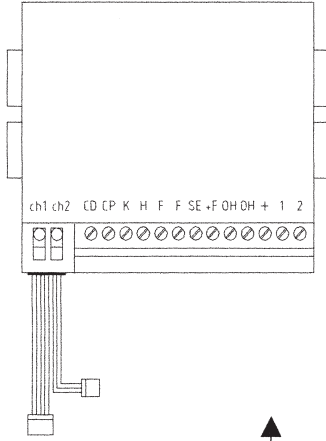

To use with
"COMPONIBILE" entrance panel



Cod. 8055/29

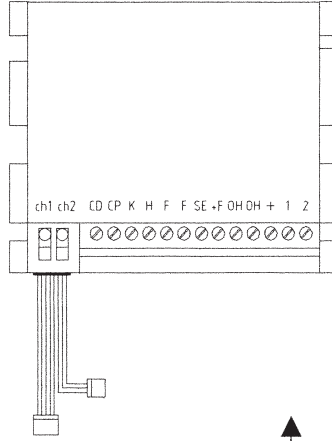

To use with
"MOSAICO" entrance panel

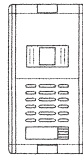

Cod. 8055/TX

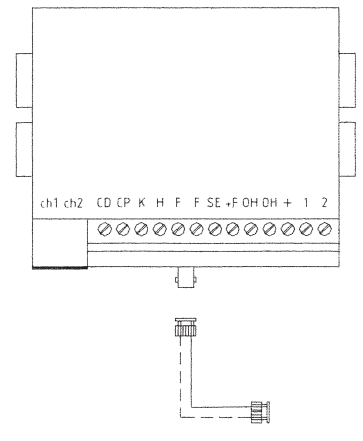

To use with
External camera

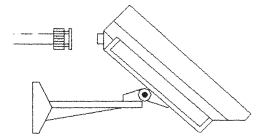

TERMINAL FUNCTIONS

Code 8055 / 80
Code 8055 / 29

T.	Value	Function	Note
CD		Common anode diodes circuits	
CP		Common push button	
K	+12 V = at rest 0 V call	Switch set	
H	0 V	General earth	All voltage reference level
F	16 V ~	Camera group supply	Stand on terminal
SE	16 V ~ opened 0 V closed	Electric lock door release	
OH	0 V	General earth	All voltage reference level
+F	+18 V =	Camera group supply	Permanent
+	+18 V =	Timed voltage	60 sec.
1		Positive video signal	Composite video signal 1 Vpp
2		Negative video signal	Composite video signal 1 Vpp
Ch1		Cathode diode	Used only in the video kit
Ch2		Cathode diode	Used only in the video kit

Cod. 8055 / TX

K	+12 V = at rest 0 V call	Switch set	
OH	0 V	General earth	All voltage reference level
+F	+18 V =	Camera group supply	Permanent
+	+18 V =	Timed voltage	60 sec.
1		Positive video signal	Composite video signal 1Vpp.
2		Negative video signal	Composite video signal 1Vpp.
	75 Ω	BNC Coaxial cable core	Composite video signal 1Vpp.

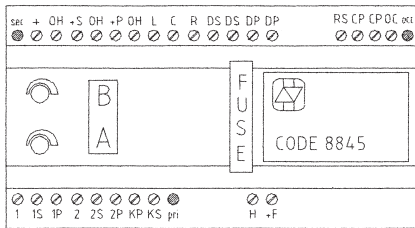

AUTOMATIC SWITCH Cod. 8845

Dimensions : 185 x 100 x 77 mm
 housing : ABS (DIN module)

Protections : fuse 1 A

LEDS :

- PRI** Common contacts close with NC contacts
- SEC** Common contacts close with NO contacts
- OCC** Busy signal works

ENGLISH

TERMINAL FUNCTIONS

T.	Value	Function	Note
----	-------	----------	------

Code 8845

+F	+18 V=	Supply	Stand on terminal
OH	0 V	General heart	All voltage reference level
KP	+12 V= at rest 0 V call	Reset control	
KS	+12 V= at rest 0 V call	Set control	
RS		Busy signal	Special function
OC		Busy signal	Special function
1		Positive video signal	Common contact
1P		Positive video signal	NC contact
1S		Positive video signal	NO contact
2		Negative video signal	Common contact
2P		Negative video signal	NC contact
2S		Negative video signal	NO contact
+	+18 V=	Monitor supply	Common contact
+P	+18 V=	Monitor supply	NC contact
+S	+18 V=	Monitor supply	NO contact
DS		Common anode diodes circuit	Common contact
DS		Common anode diodes circuit	NO contact
DP		Common anode diodes circuit	Common contact
DP		Common anode diodes circuit	NC contact
CP		Common push buttons	Common contact
CP		Common push buttons	NC contact
C		Auxiliary contact	Common contact
R		Auxiliary contact	NC contact
L		Auxiliary contact	NO contact

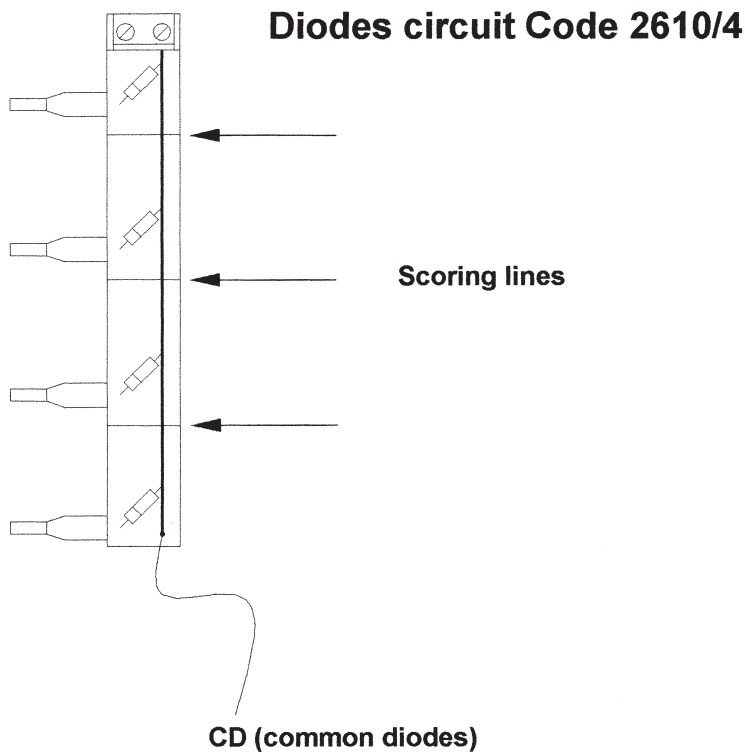
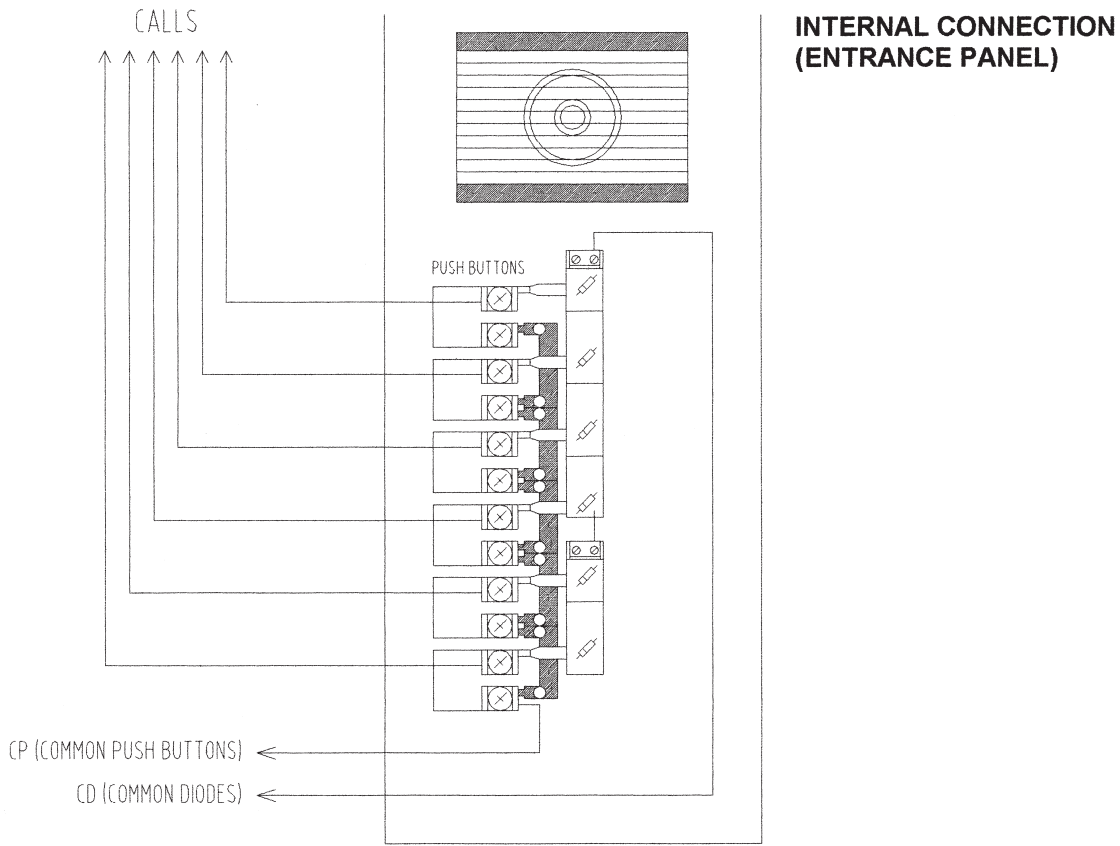

SYNTHESI
COD. 8435/5

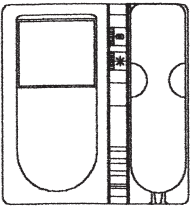

- R
- +
- 0
- 2
- 1
- CP
- X
- CR
- CC
- CL

PULSANTIERA
ENTRANCE PANEL

COD. 8505/P1

COD. 8061/1

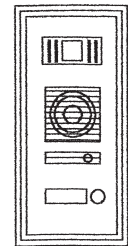
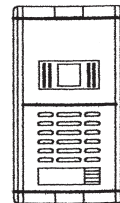

ALIMENTATORE
POWER SUPPLY
COD. 8605

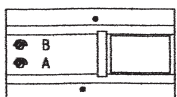

- +
- CT
- H
- +F
- F
- H
- 220

RETE
MAIN

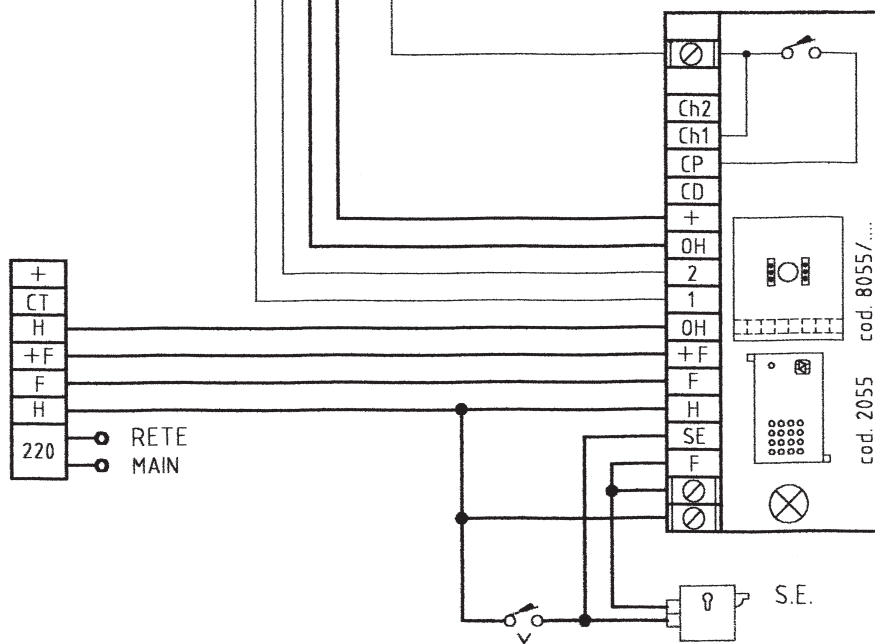

SCHEMI WIRING DIAGRAMS



SYNTHESI
COD. 8435/5

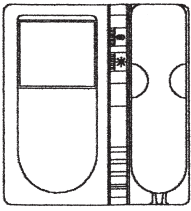

- R
- CP
- +
- 0
- 2
- 1
- X
- CR
- CC
- CL

MODULO TELEC.
CAMERA MODULE
COD. 8055/TX

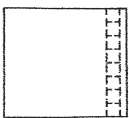

- 1
- 2
- OH
- +
- K
- +F
- OH

ALIMENTATORE
POWER SUPPLY
COD. 8605

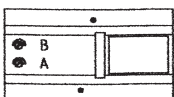

- +
- CT
- H
- +F
- F
- H
- 220

RETE
MAIN

TELECAMERA IN CUSTODIA
EXTERNAL CAMERA

RETE
MAIN

cod. 2054

PULSANTIERA
ENTRANCE PANEL

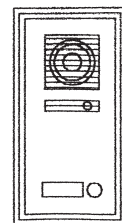

S.E.

Kit unifamiliare con telecamera esterna
Single residence kit with external camera

sch. 5811#

SYNTHESI
COD. 8435/5

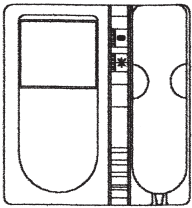

SYNTHESI
COD. 8435/5

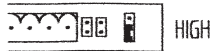
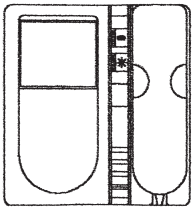

ALIMENTATORE
POWER SUPPLY
COD. 8605

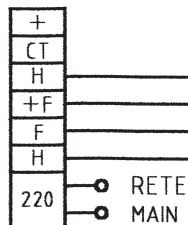
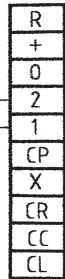
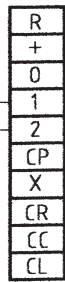
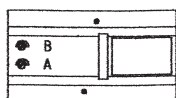

PULSANTIERA
ENTRANCE PANEL
COD. 8505/P2DP COD. 8061/2

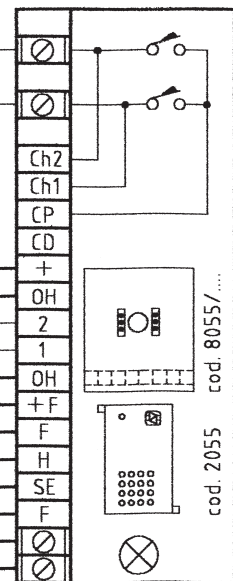
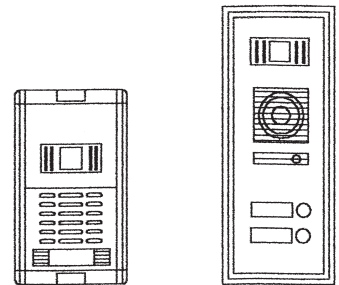

SCHEMI WIRING DIAGRAMS

Kit bifamiliare
Dual residence kit

sch. 5802#



AMPLIVOX

SYNTHESI
COD. 8435/5

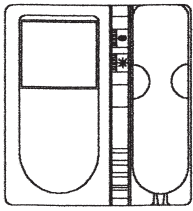

HIGH

SYNTHESI
COD. 8435/5

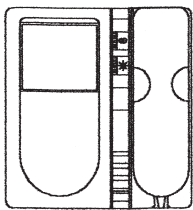

HIGH

MODULO TELEC.
CAMERA MODULE
COD. 8055/TX

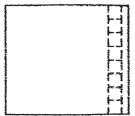

ALIMENTATORE
POWER SUPPLY
COD. 8605

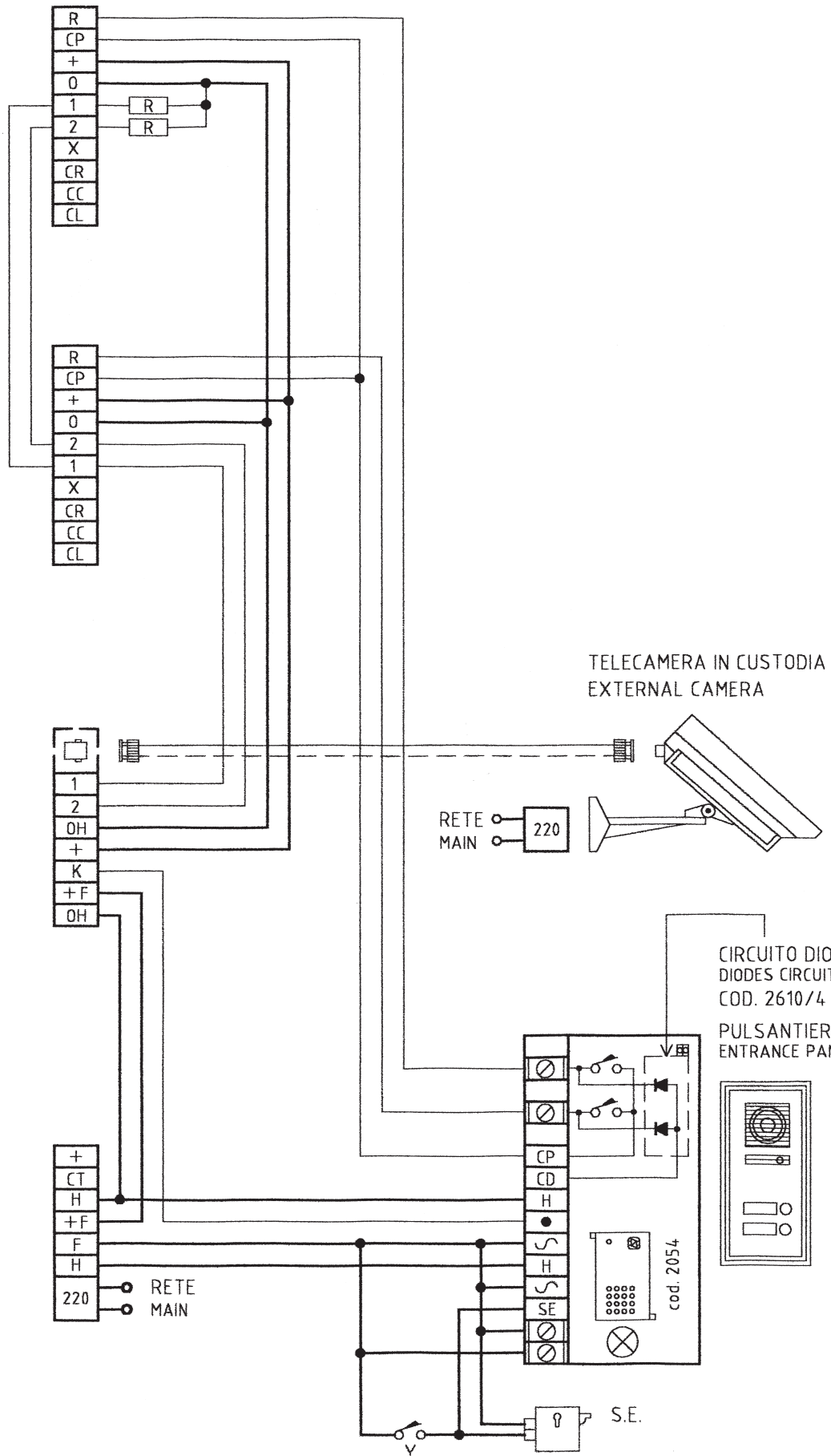
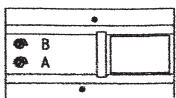

Kit bifamiliare con telecamera esterna
Dual residence kit with external camera

sch. 5812#

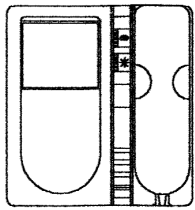

SYNTHESI
COD. 8435/5

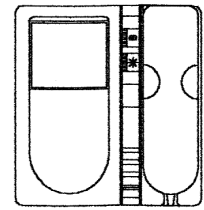
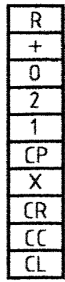

SYNTHESI
COD. 8435/5

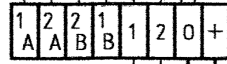

DERIVATORE
DISTRIBUTOR
COD. 865/4

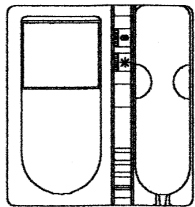

SYNTHESI
COD. 8435/5

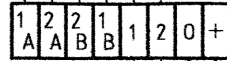
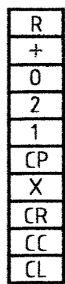

DERIVATORE
DISTRIBUTOR
COD. 865/4

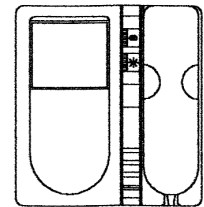

SYNTHESI
COD. 8435/5

CIRCUITO DIODI
DIODES CIRCUIT
COD. 2610/4
PULSANTIERA
ENTRANCE PANEL
COD. 806.../N

ALIMENTATORE
POWER SUPPLY
COD. 8605

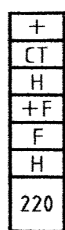
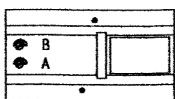

RETE
MAIN

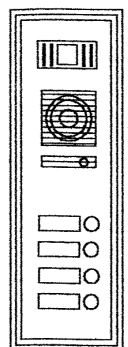
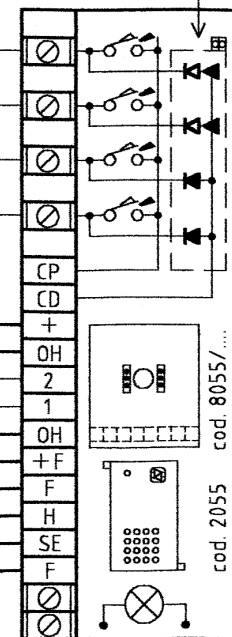

SCHEMI WIRING DIAGRAMS

Impianto plurifamiliare
Multi users video door entry system

sch. 5820#

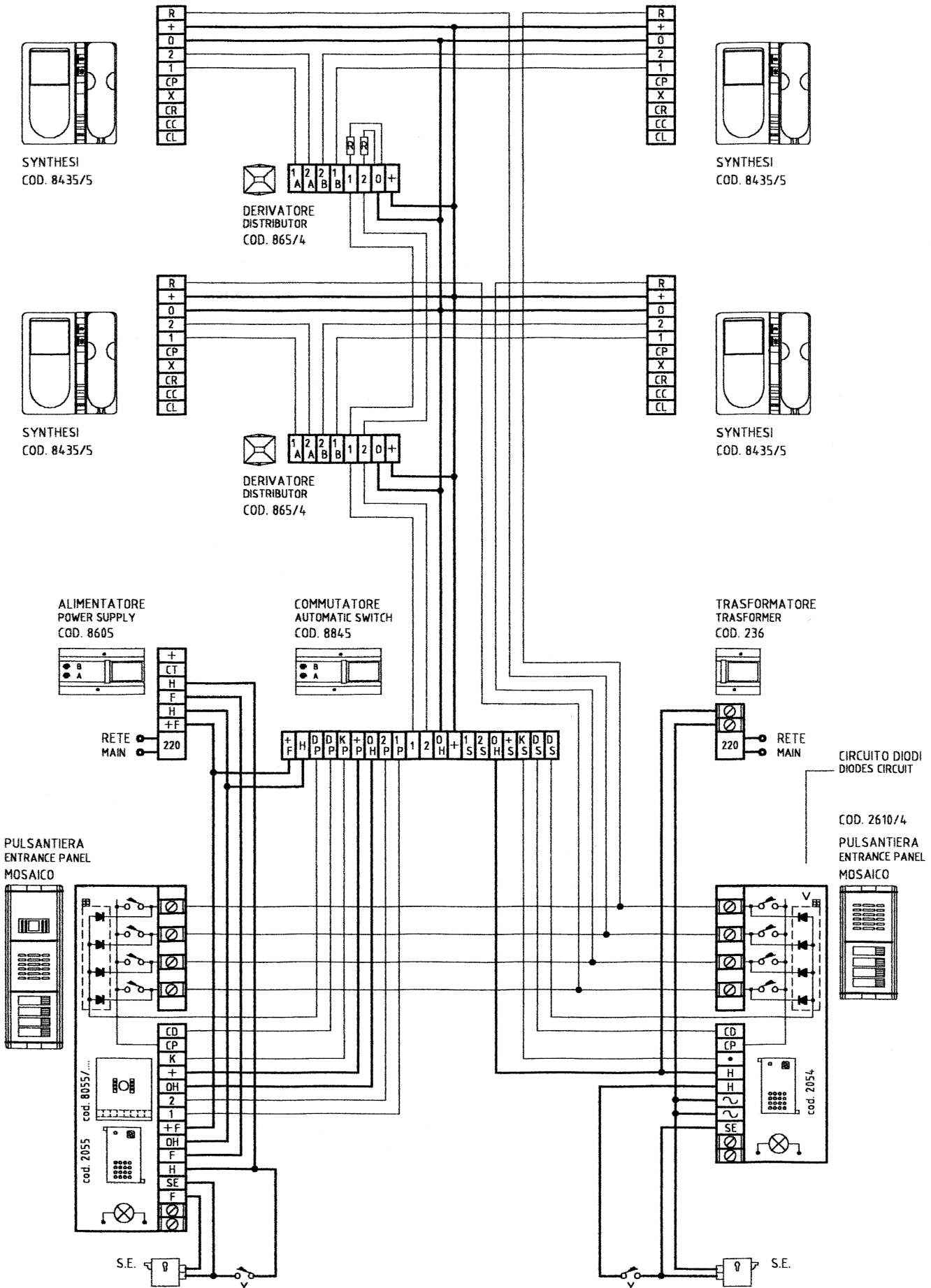

Impianto commutato : una pulsantiera video e una audio sch. 5840#
 Automatic switching for two entrance panel : one video and one only audio



installation wiring diagrams

VIDEO SYSTEM 4+n

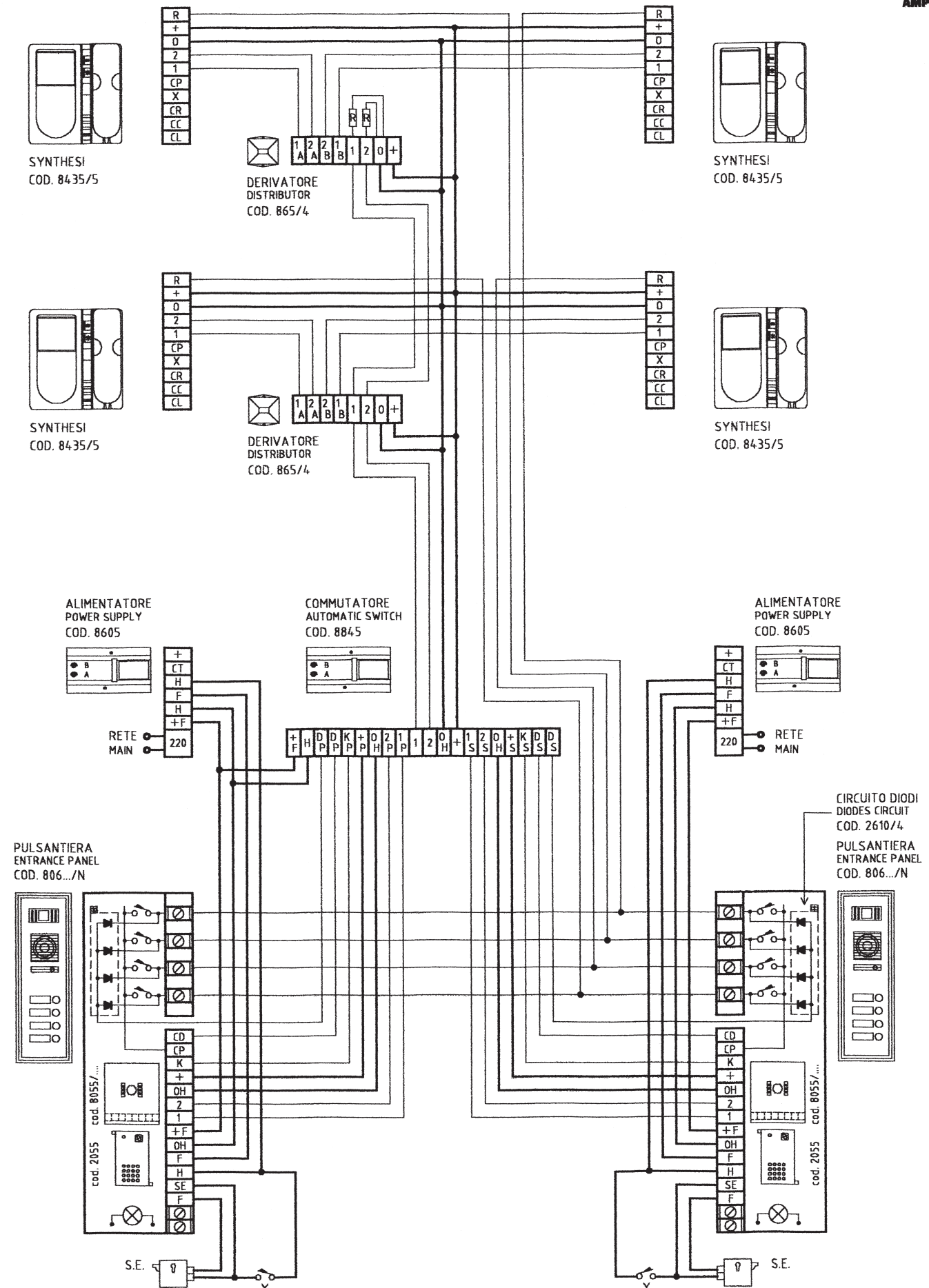

SCHEMI WIRING DIAGRAMS

Impianto commutato : due pulsantiere videocitfoniche sch. 5841#
Automatic switching for two video entrance panel

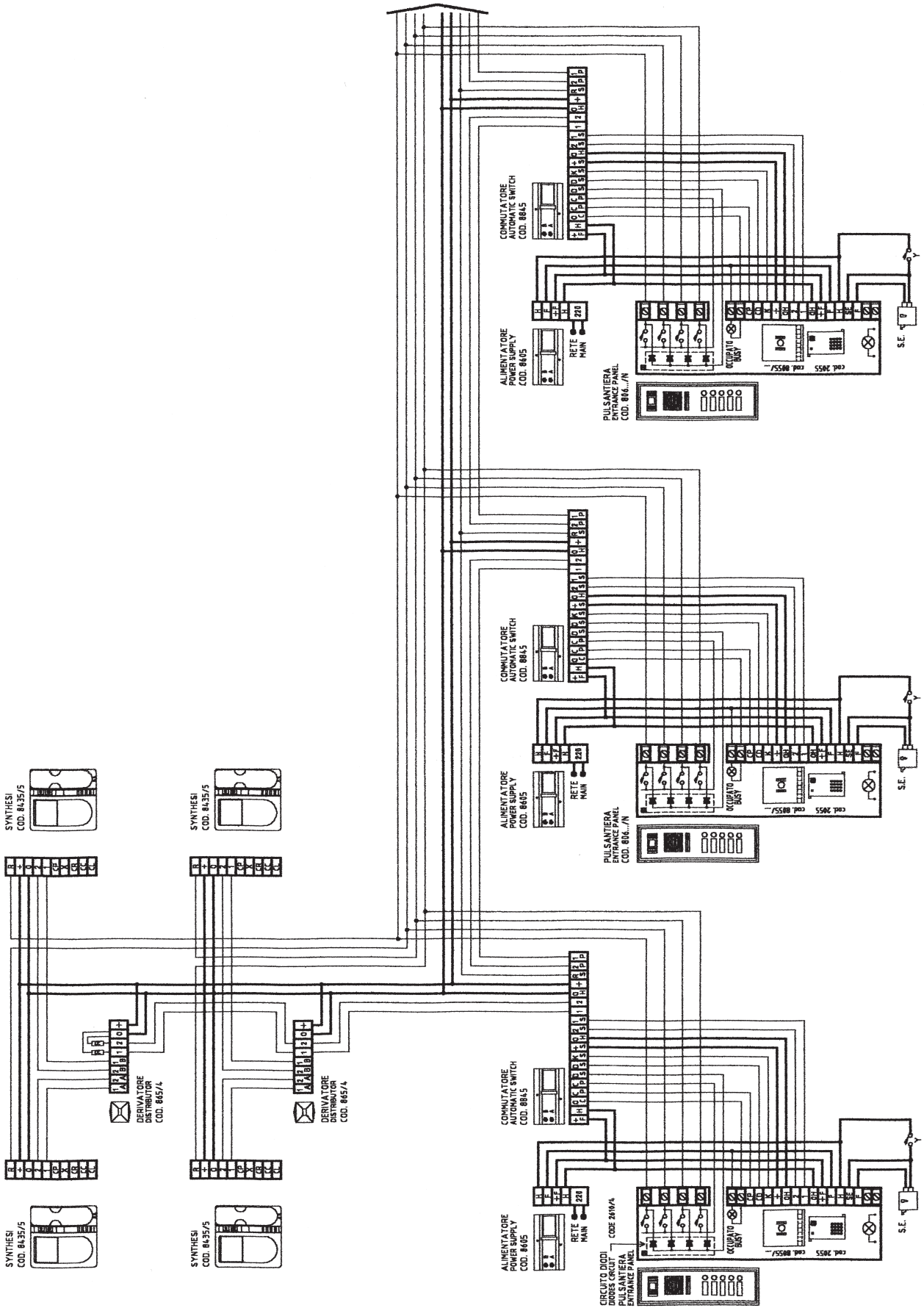

Impianto commutato : tre o più pulsantiere videocitofoniche principali sch. 5851#
 Automatic switching for three or more main video entrance panels

DERIVATORE VIDEO FINALE
FINAL VIDEO DISTRIBUTOR

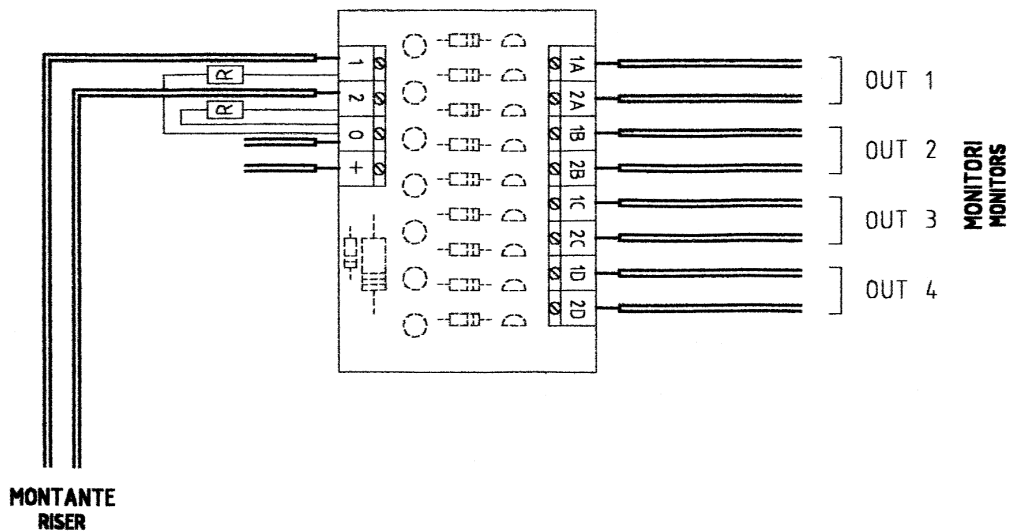

DERIVATORE VIDEO DI PIANO
FLOOR VIDEO DISTRIBUTOR

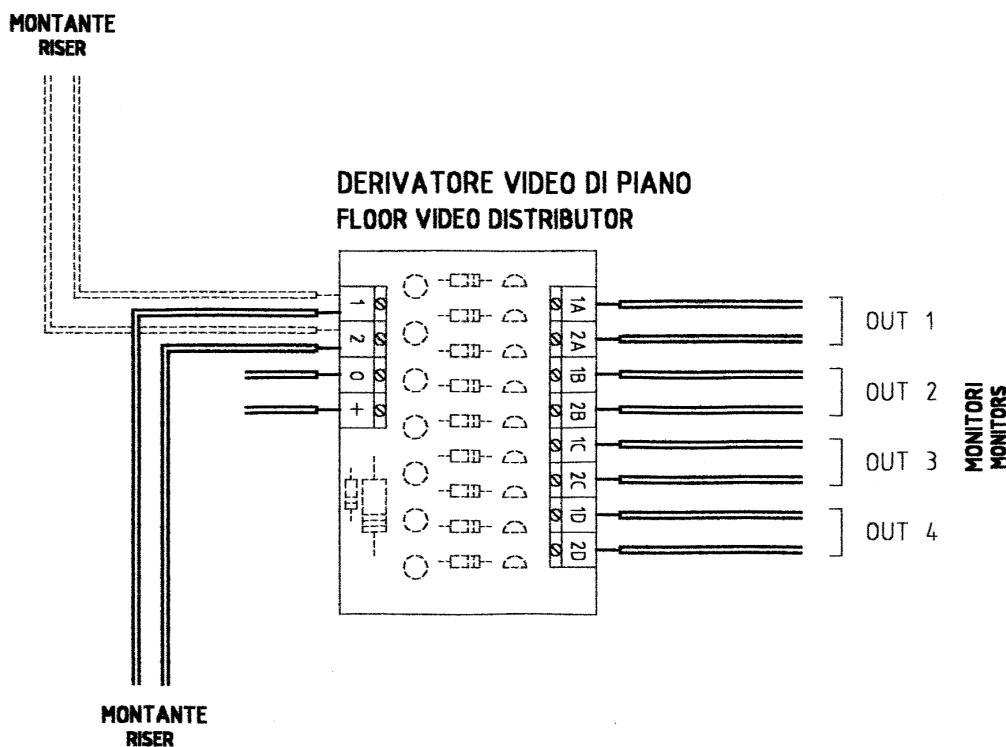

SCHEMI WIRING DIAGRAMS

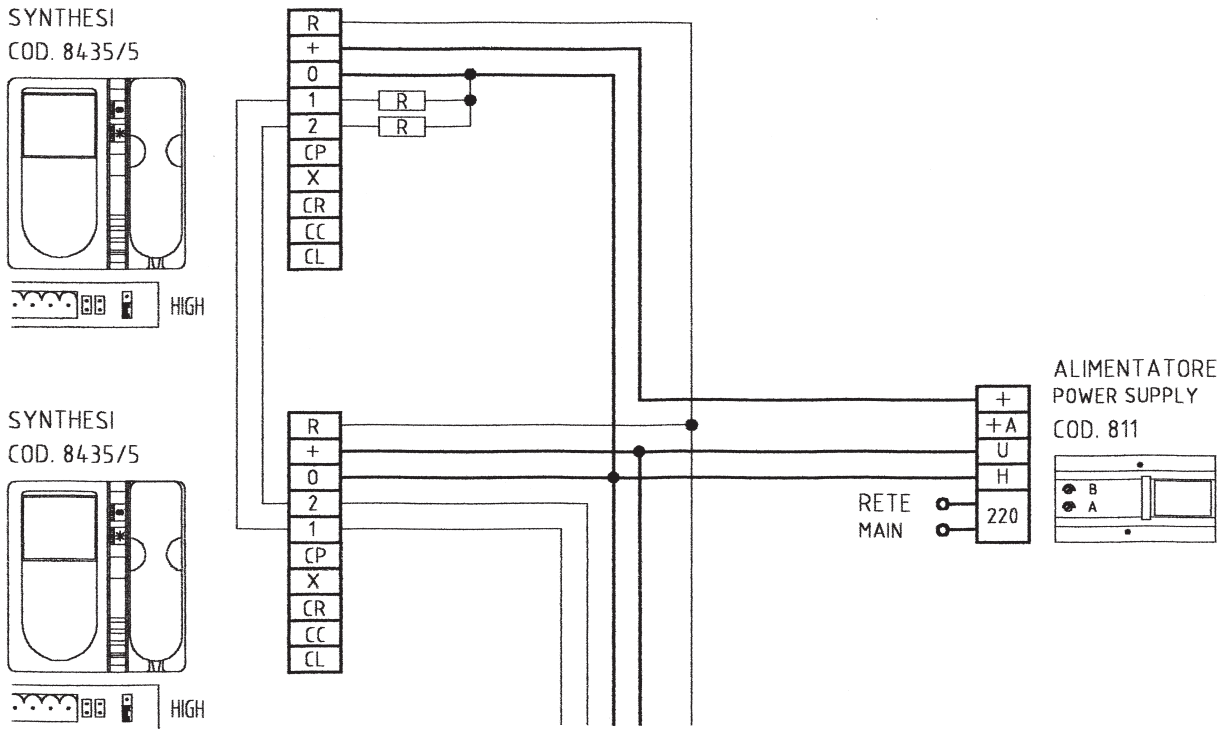

Collegamento di un monitor in parallelo
Monitor in parallel

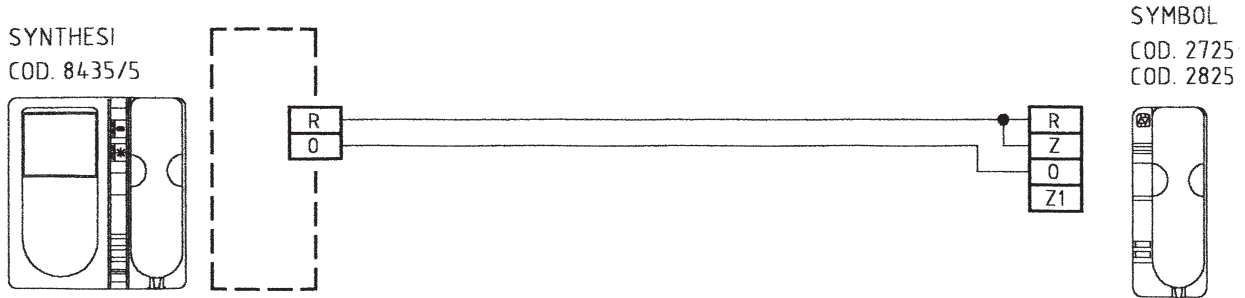

IMPORTANTE :

- COD. 2725 : CITOFONO 2 FILI SENZA SEGRETO DI CONVERSAZIONE
- COD. 2825 : CITOFONO 2 FILI CON SEGRETO DI CONVERSAZIONE

IMPORTANT :

- CODE 2725 : TELEPHONE 2 WIRES WITHOUT PRIVACY
- CODE 2825 : TELEPHONE 2 WIRES WITH PRIVACY

NOTE :

- COLLEGARE MAX 2 CITOFONI IN PARALLELO
- MAX 2 TELEPHONES IN PARALLEL

Collegamento di un citofono in parallelo
Telephone in parallel

SYNTHESI
COD. 8435/5

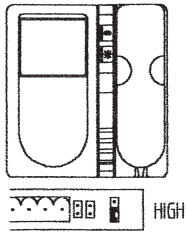

SYNTHESI
COD. 8435/5

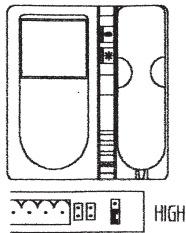

SYNTHESI
COD. 8435/5

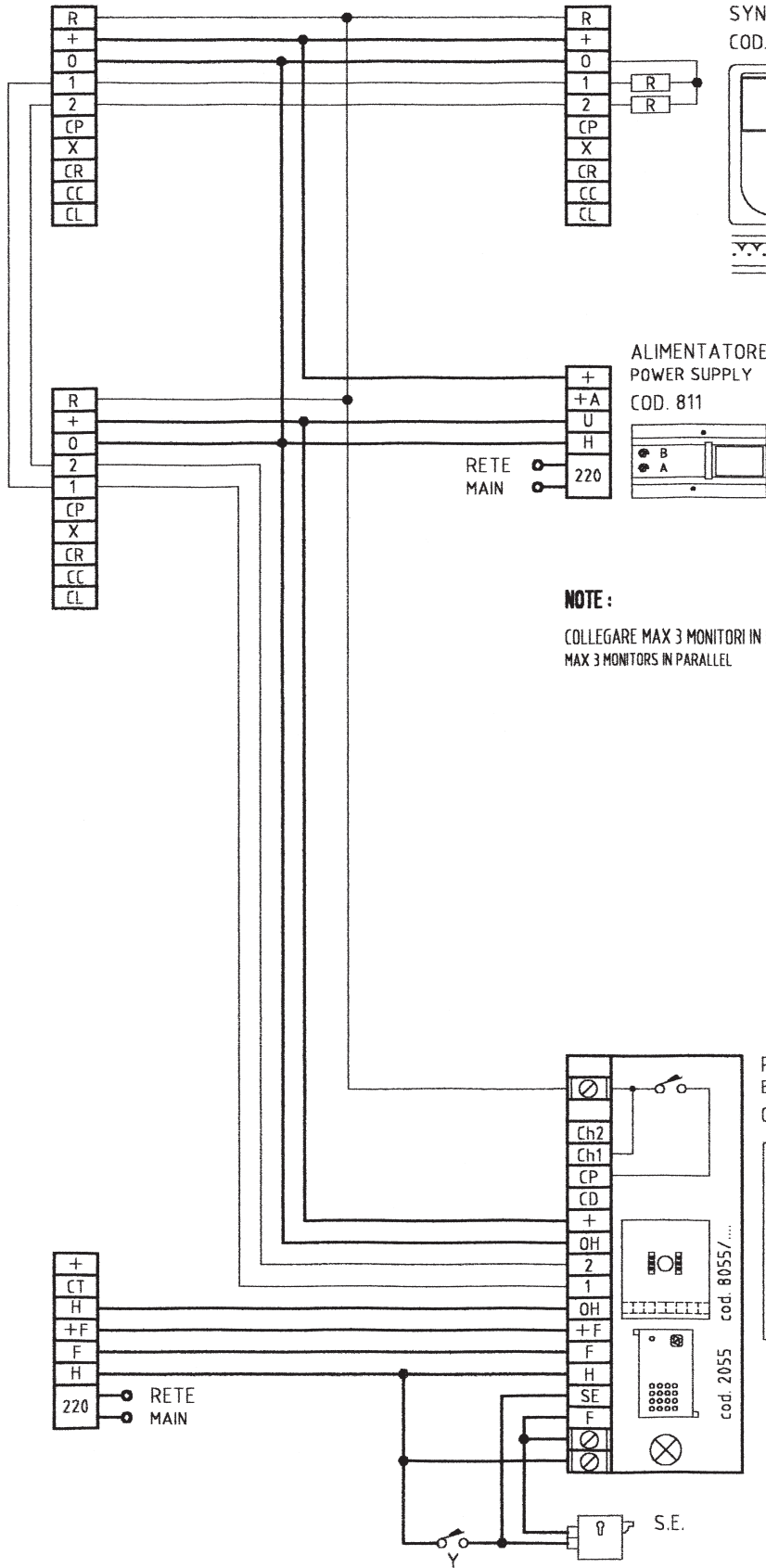
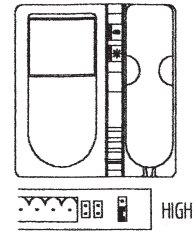

NOTE :
COLLEGARE MAX 3 MONITORI IN PARALLELO
MAX 3 MONITORS IN PARALLEL

Collegamento di tre monitori in parallelo senza derivatore
Three monitors in parallel without video distributor

SCHEMI WIRING DIAGRAMS

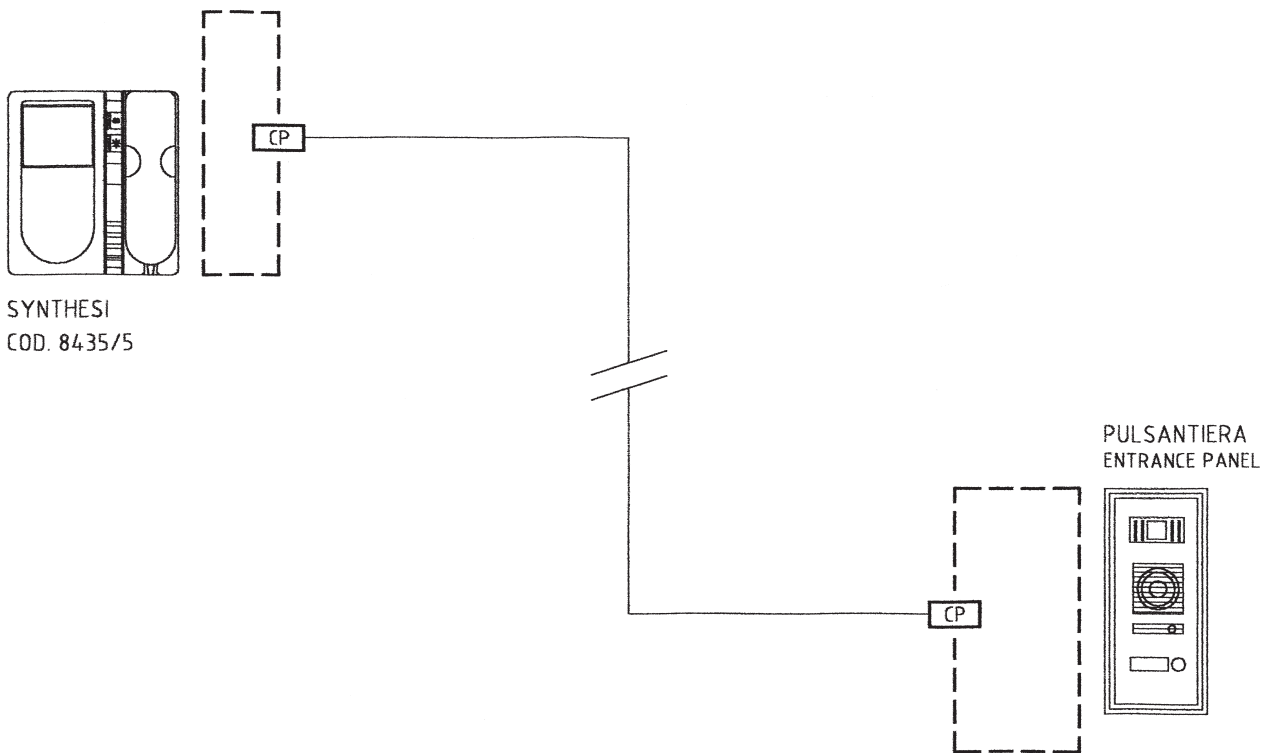

Collegamento con richiamo video dal monitor
Monitor with video recall

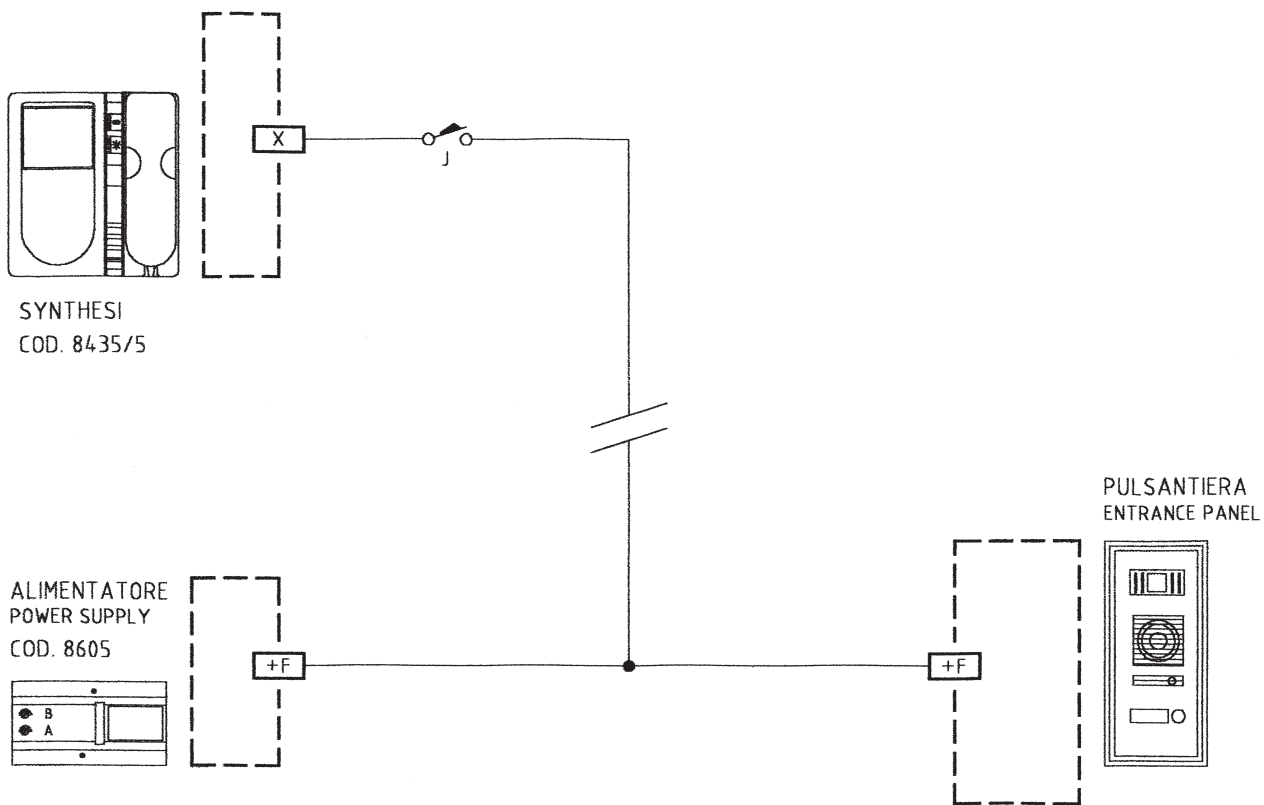

Collegamento con chiamata di piano
Apartment entrance door call

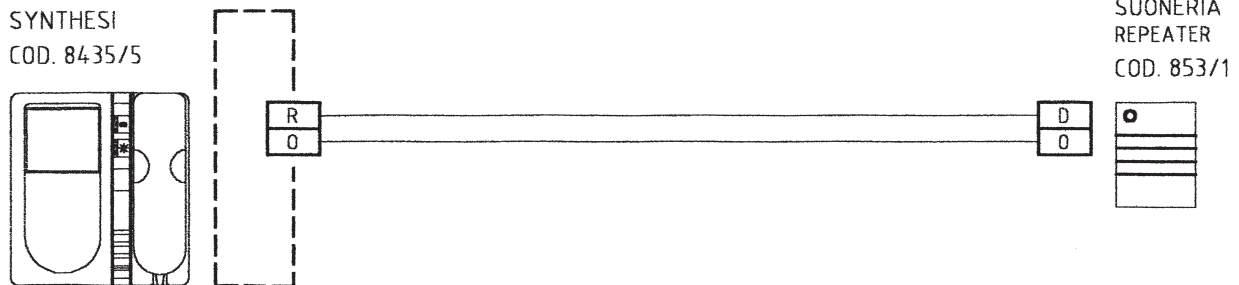

Collegamento del ripetitore di chiamata
Passive repeater for additional call

Cod. 853/1

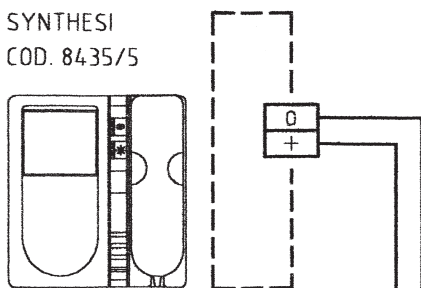

IMPORTANTE :

EFFETTUARE LA SEGUENTE MODIFICA QUANDO :

- a) LA DISTANZA FRA LA PULSANTIERA E L'ALIMENTATORE SUPERA I 100 METRI.
- b) LA TENSIONE MISURATA TRA I MORSETTI "+" e "0" DELL'ULTIMO MONITORE RISULTI INFERIORE AI 15Vcc.

IMPORTANT :

USE THIS CONNECTION WHEN :

- a) THE DISTANCE BETWEEN ENTRANCE PANEL AND POWER SUPPLY IS MORE THAN 100 mt.
- b) THE VOLTAGE BETWEEN THE CONTACTS "+" and "0" OF THE LAST MONITOR CONNECTED IS LOWER THAN 15Vdc.

ALIMENTATORE SUPPLEMENTARE
ADDITIONAL POWER SUPPLY
COD. 8605

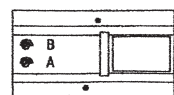

COD. 8605

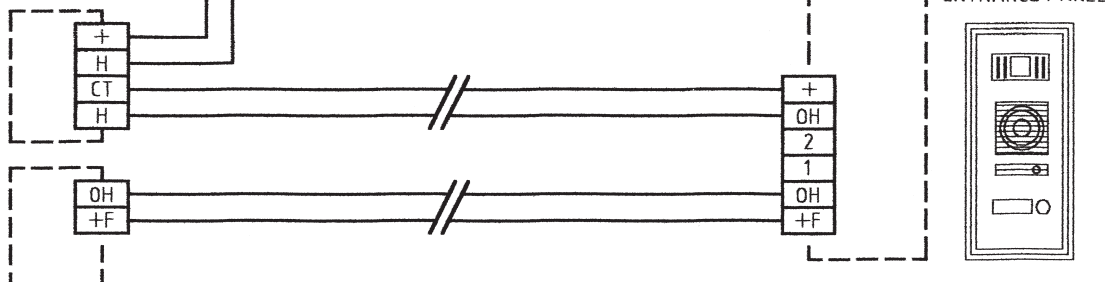
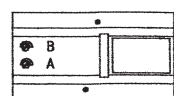

Collegamento in caso di lunghe distanze
Long distance connection

SCHEMI WIRING DIAGRAMS

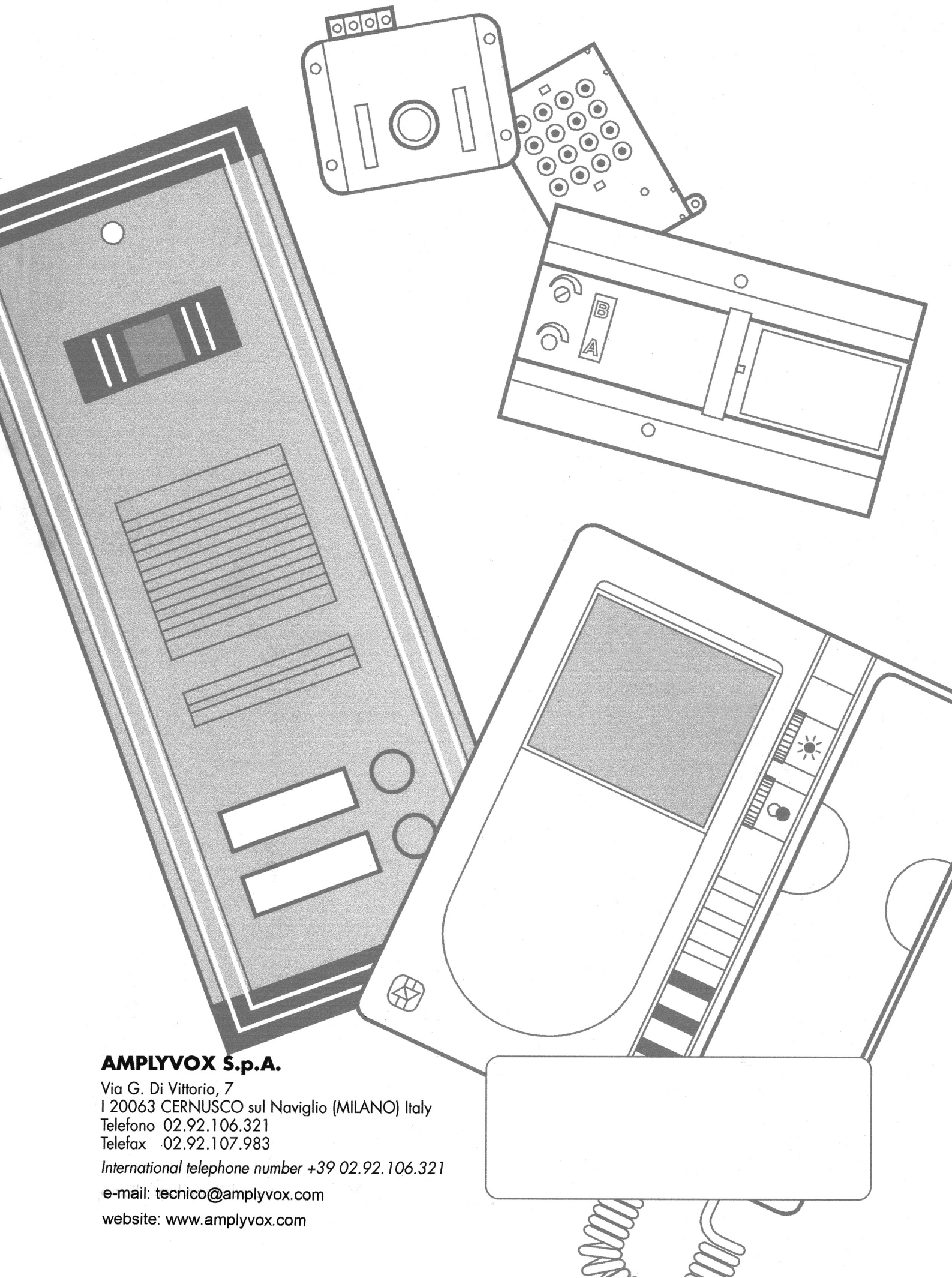

AMPLYVOX S.p.A.

Via G. Di Vittorio, 7
I 20063 CERNUSCO sul Naviglio (MILANO) Italy
Telefono 02.92.106.321
Telefax 02.92.107.983

International telephone number +39 02.92.106.321

e-mail: tecnico@amplyvox.com

website: www.amplyvox.com